

# Karta produktu

Kod: **CB70**

**CURE BLACK walk-in, 700 mm, szkło czyste**



TYP	Y
CB70	680-695
CB80	780-795
CB90	880-895
CB100	980-995
CB110	1080-1095

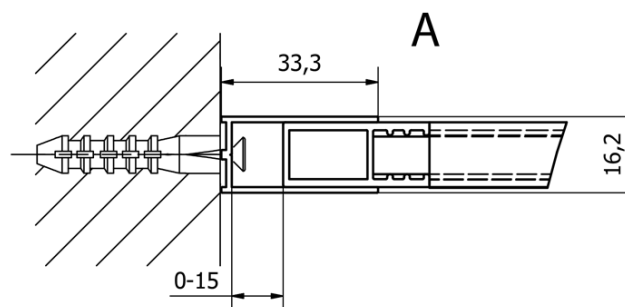
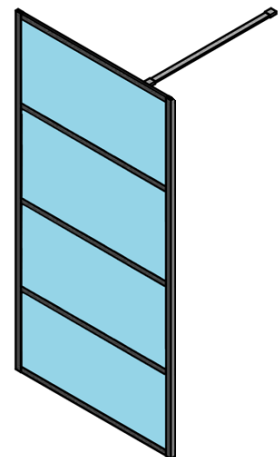
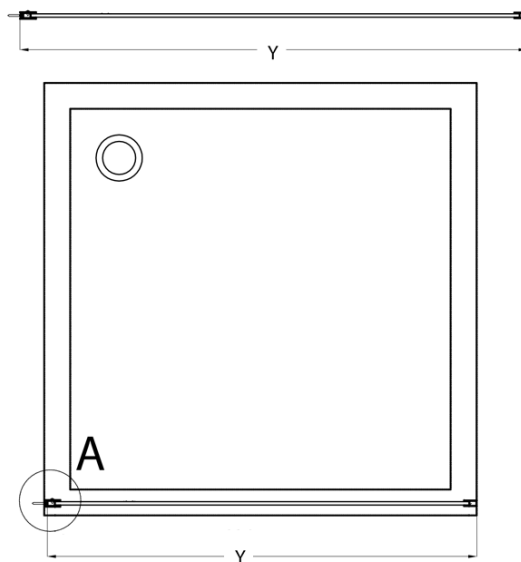

TYP	X
CB70+CB350	686-701
CB80 +CB350	786-801
CB90 +CB350	886-901
CB100 +CB350	986-1001
CB110 +CB350	1086-1101

