

Karta produktu

Kod: **CB140**

CURE BLACK walk-in 1400 mm, szkło czyste

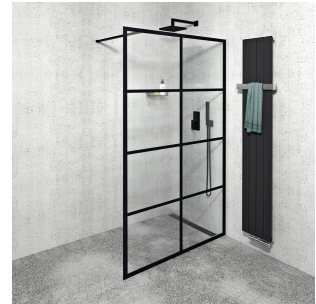

TYP	Y
CB120	1180-1195
CB140	1380-1395

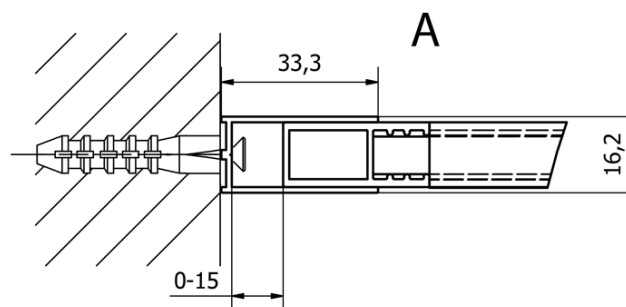
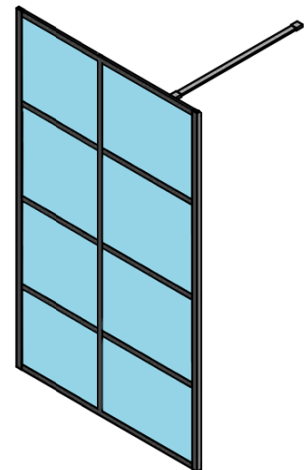
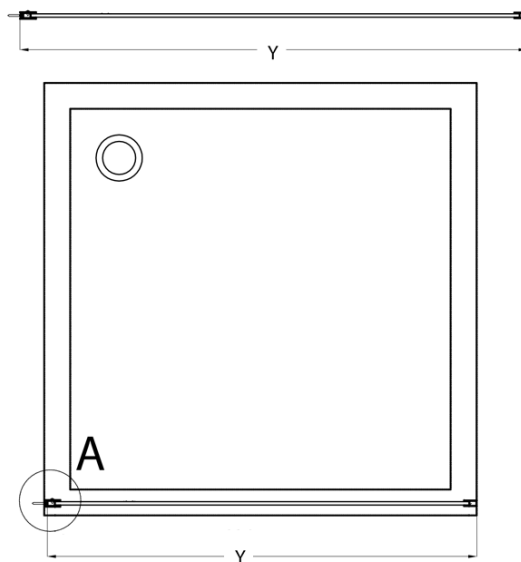

TYP	X
CB120+CB350	1186-1201
CB140+CB350	1386-1401

